

BLACK COUNTRY LIVING MUSEUM

VENUE HIRE

A timeless venue in the Black Country with endless opportunities.



WELCOME TO BLACK COUNTRY LIVING MUSEUM

Welcome to Black Country Living Museum, where you can discover how the history of a small region made a big impact on the people, culture, and industry of the world. With a range of spaces, excellent in-house catering, and access to 300 years of history, our dedicated team will work with you to create your perfect event.



HIRE US FOR

- CONFERENCES, AGMS & SUMMITS
- TEAM MEETINGS
- AWAY PACKAGE PACKAGES
- COMPANY FAMILY FUN DAYS
- EVENING COMPANY CELEBRATION EVENTS
- PRIVATE PARTIES
- PROMS & GRADUATIONS
 - Please see the prom brochure on our website
- WEDDING CELEBRATIONS
 - Please see the wedding celebrations brochure on our website

[Click here to view
the venues in 360°](#)



VISITOR CENTRE

Hireable from 07.30-09.30 or 18.00-22.30

The Visitor Centre is perfect for a seated dinner, drinks reception or seminar. Hire our Café alone for a morning networking event or quiz night.

THE PATRICK ATRIUM

Seating Plan	Capacity
Theatre	150
Cabaret	70
Drinks Reception	250

CAFE BLACK COUNTRY

Seating Plan	Capacity
Theatre	150
Seated	80
Both Include	Event set up Events support Car parking AV facilities

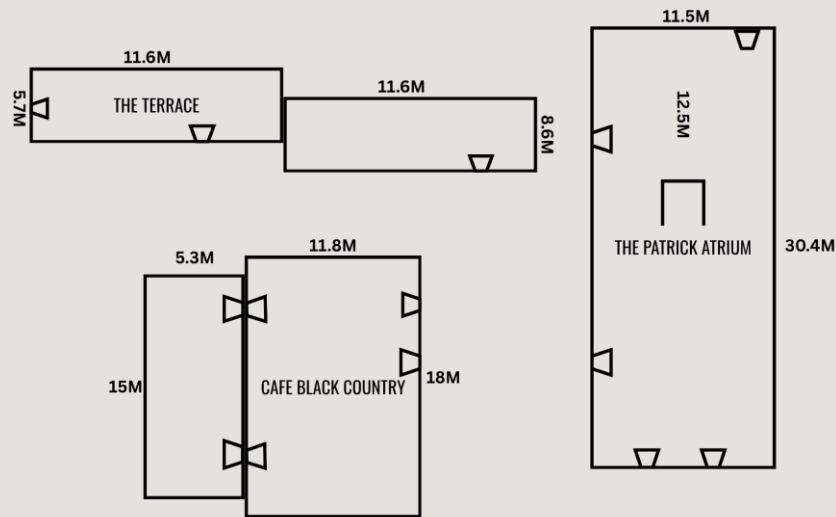

“Everyone who attended was extremely complimentary about the facilities! The staff were so helpful and organised!”

CONFERENCE HALL

Hireable Monday - Sunday for full or half days

Originally Smethwick's Rolfe Street Public Baths, the Conference Hall is situated within our Conference & Learning Centre. This space is perfect for conferences, award ceremonies and large celebrations.

CONFERENCE HALL	
Seating Plan	Capacity
Theatre	200
Cabaret	120, 150 without stage
Includes	Event set up Events support Car parking AV facilities

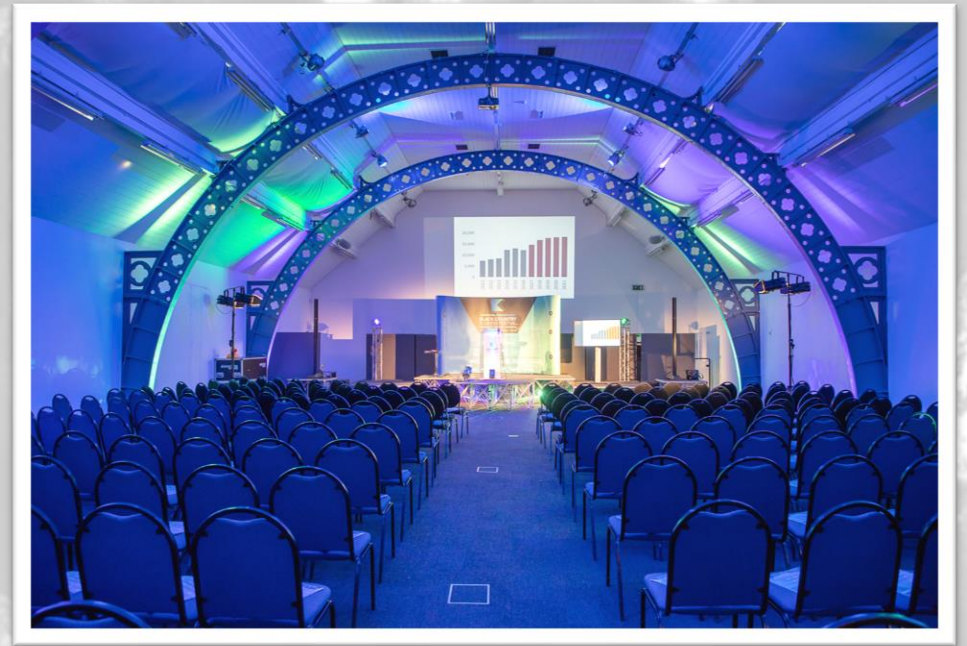
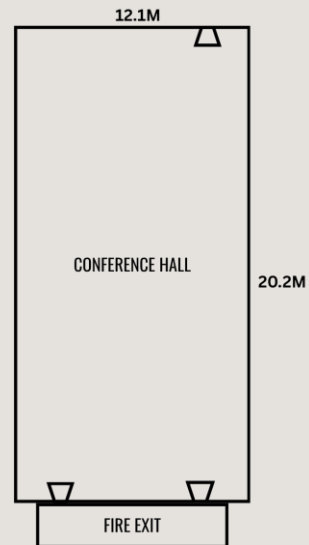

"The spaces available are amazing. They comfortably accommodated our numbers and were well-equipped with everything we needed for a corporate event. Even items we hadn't thought of and requested last-minute were available and added to the event plan."



EXHIBITION HALL

Hireable Monday - Sunday for full or half days

Situated next to the Conference Hall, our Exhibition Hall can be hired as a dedicated refreshment, breakout or exhibition space.

EXHIBITION HALL	
Seating Plan	Capacity
Theatre	150
Cabaret	80
Includes	Event set up Events support Car parking AV facilities

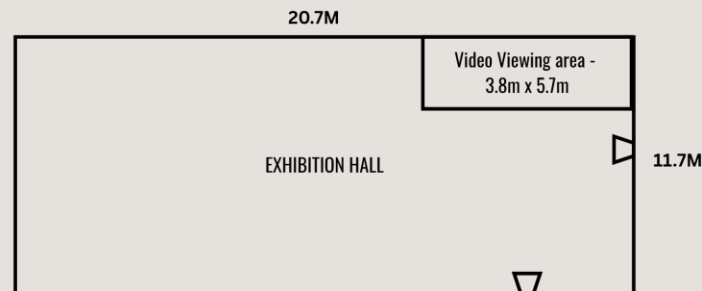

"What a venue! The projector and speaker system was first rate and wow was the room set up perfectly! Absolutely loved that you guys got the brief and there was zero to change anywhere!"



WORKERS' INSTITUTE

Hireable Evenings from 18.00 - 22.30

The Workers' Institute stands as a monument to the struggle of the women chain makers of Cradley Heath. This historic building is perfect for informal dinners, wedding receptions and celebration events, or seminars.

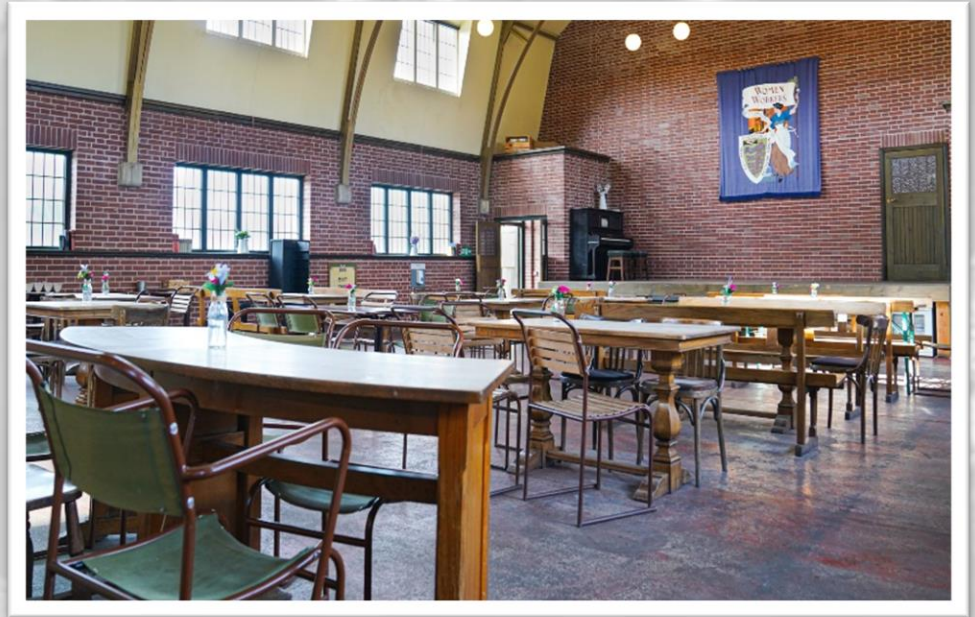

WORKERS' INSTITUTE

Seating Plan

Capacity

Theatre 180

Cabaret 120

Mezzanine 60 seated

Includes
Event set up
Events support
Car parking
AV facilities

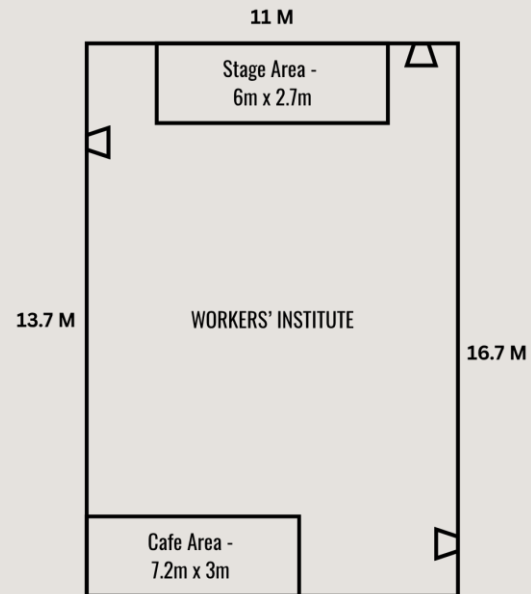

WORKERS' INSTITUTE: COMMITTEE ROOM

Hireable Monday - Sunday for full or half days

Located on the first floor of the Workers' Institute, the Committee Room provides the perfect space for a boardroom style meeting, or as the base for a team away day.

WORKERS' INSTITUTE – COMMITTEE ROOM	
Seating Plan	Capacity
Theatre	30
Boardroom	18
Includes	Event set up Events support Car parking AV facilities

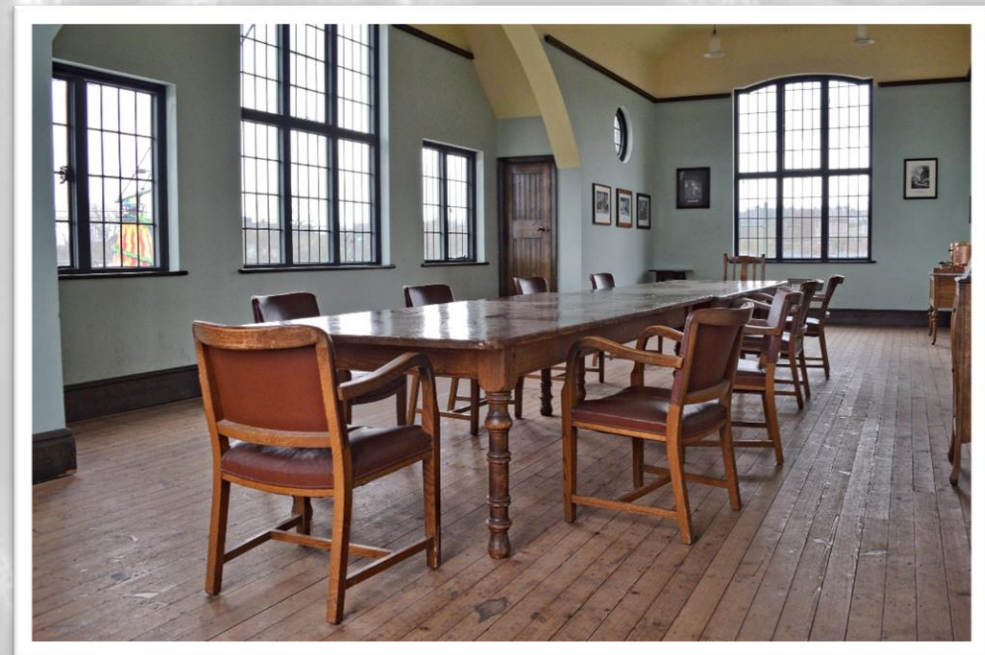
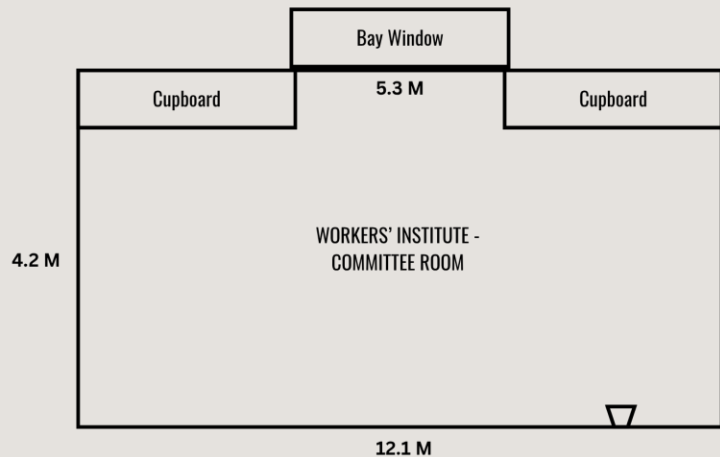

"The Workers institute Committee Room was a perfect fit for our needs. It provided an ideal spacious setting for our two-day leadership course!"



WOODSIDE LIBRARY FUNCTION ROOM

Hireable Monday – Sunday for full or half days

Woodside Library, originally opened in 1894 on Stourbridge Road, was a gift from the Earl of Dudley, serving the community until its closure in 2008. This is perfect for small meetings, AGMs and small lectures, or daytime vow renewals.

WOODSIDE LIBRARY – FUNCTION ROOM

Seating Plan	Capacity
Theatre	40
Cabaret	20
Vow Renewal	32
Includes	Event set up Events support Car parking AV facilities

6 M

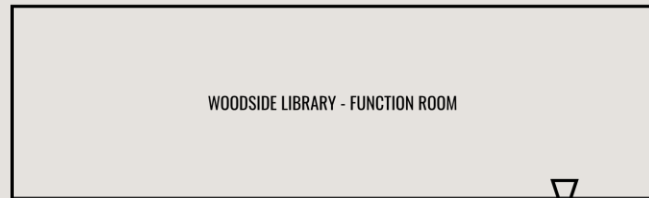

ELEPHANT & CASTLE PUB

Hire our Lounge in the daytime Monday - Friday for full or half days (except school holidays) or the whole pub from 18:00-22:30

The Elephant and Castle Pub is a recreation of a once iconic Edwardian pub in Wolverhampton. Hire the entire pub for an evening event or one of our upstairs rooms for a meeting with a difference in the heart of the historic site.

THE LOUNGE & CLUB ROOM

Seating Plan	Capacity
Theatre	40
Cabaret	50

WHOLE BUILDING HIRE

Seating Plan	Capacity
Across both floors	100
Includes	Event set up Events support Car parking AV facilities

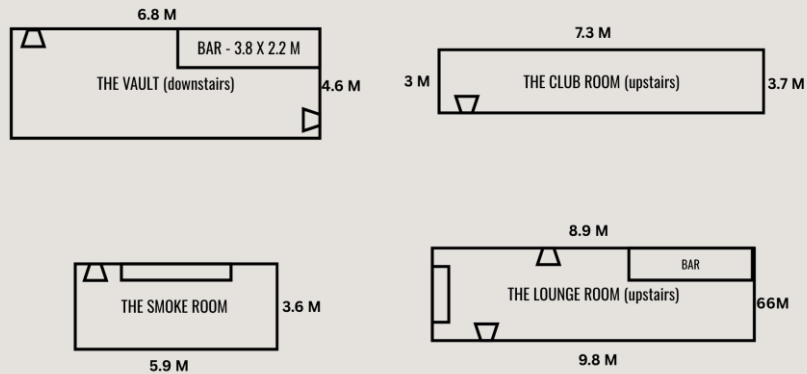

BOTTLE & GLASS INN

Hireable on evenings from 18.00 - 22.30

Dating back to the late eighteenth century, the Bottle & Glass Inn once stood in Brierley Hill Road, Dudley. Inside, you can find sawdust on the floor, paraffin lamps and candles, and a piano for a late-night sing-along. Hire the entire pub for an evening event or as part of your historic experience.

BOTTLE & GLASS INN	
Seating Plan	Capacity
Across pub and yard bar	60
Includes	Event set up Events support Car parking AV facilities

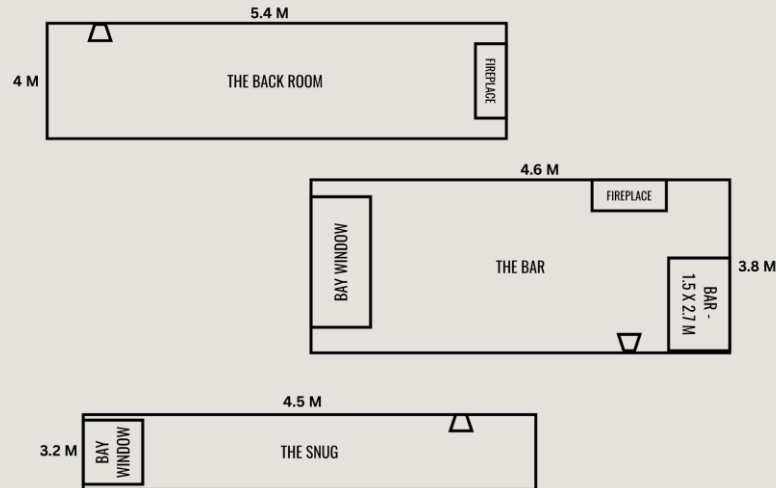

"All staff present were friendly, helpful and went out of their way to make the visit as interesting and realistic to the period as possible."



CRICKET FIELD BRICKWORKS

Hireable on evenings from 18.00 - 22.30

Immerse yourself in our Cricket Field Brickworks, a historic space shaped by generations of industrial innovation. Today, that industrial legacy lives on in the character of the space itself it offers a distinctive setting for events, gatherings, and creative activity rooted in local history.

Brickworks	
Seating Plan	Capacity
Cafeteria style	66
Standing	100
Includes	Event set up Events support Car parking AV facilities

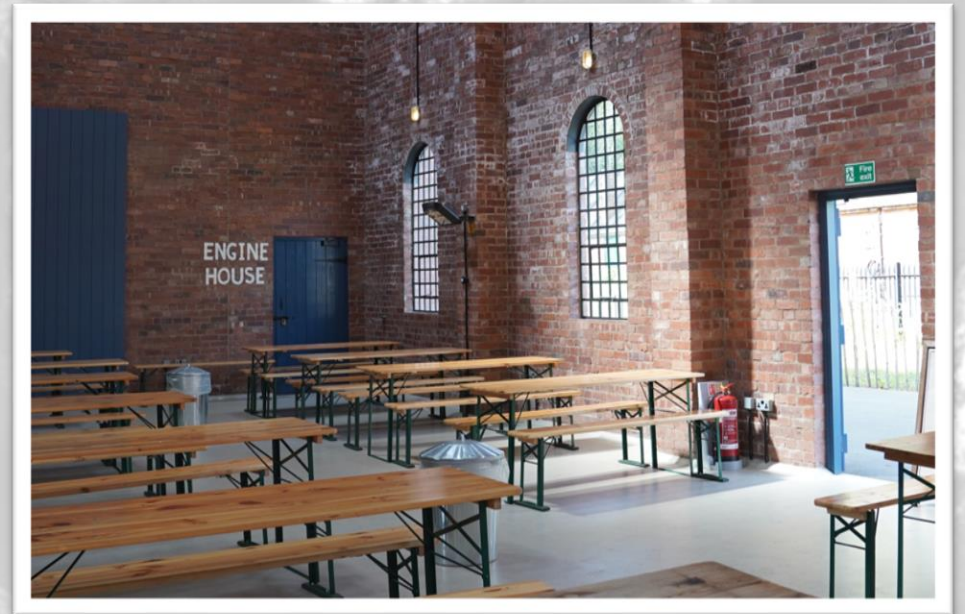
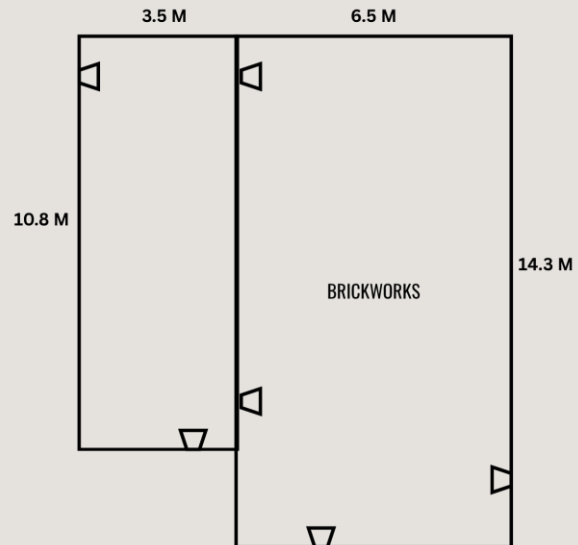

LEARNING CLASSROOMS

Only available to hire during weekends, school holidays and closed days on Monday and Tuesday during November and March.

Our modern and purpose-built classrooms are perfect for breakout sessions.

Learning Classrooms	
Seating Plan	Capacity
Classroom	40
Includes	Event set up Events support Car parking AV facilities

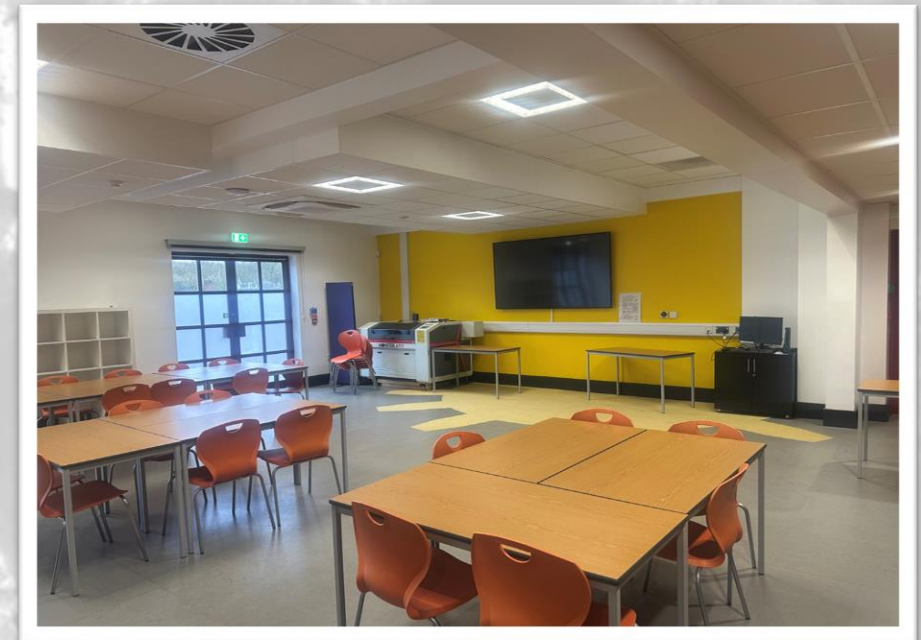
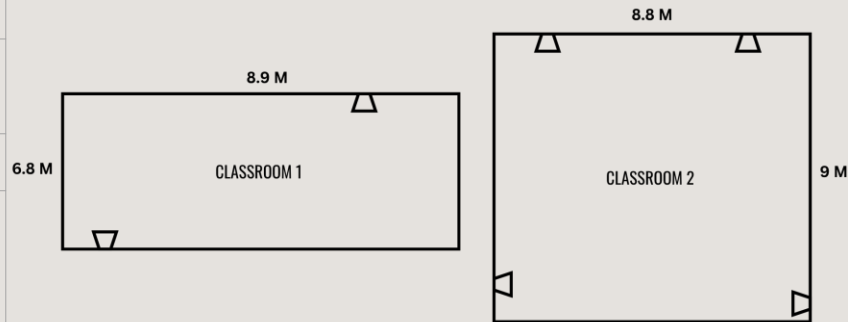

EXCLUSIVE EVENING STREET HIRE: 1800s Edwardian Village

Hireable on evenings from 18.00 – 22.30

We recommend a minimum of 80 delegates for this experience.

Enjoy an immersive experience in our Edwardian Village.

Street hire includes :

- Hobbs' & Sons Fish and Chip Shop
 - Bottle and Glass Inn
 - Emile. Doos Chemist
 - Gregory's General Store
 - T. Cooks Sweet Shop
 - Veal's Baker Shop
 - Anchormakers
- 1x roaming character, 4x shop character

Combine with our other historic experiences for a larger event.



"Words do not fully express how impressed and grateful I am for BCLM being the amazing location to celebrate our anniversary."



EXCLUSIVE EVENING STREET HIRE: 1930s Street

Hireable on evenings from 18.00 – 22.30

We recommend a minimum of 50 delegates for this experience.

Enjoy an immersive evening on Old Birmingham Road, our 1930s street.

Street hire includes :

- Hobbs' & Sons Fish and Chip Shop
 - Elephant and Castle Pub
 - Workers' Institute
 - Moralls Gentleman Outfitters
 - Griptons Radio Shop
 - Harthills' Motorbike Store
- 1x roaming character, 2x shop characters

Chat to our shopkeepers and take in what it was like in the 1930s.

Combine with our other historic experiences for a larger event.

"The characters in the street/shops were really engaging, and their knowledge was outstanding - adding to the immersive experience we were hoping for during our first 60 minutes on site whilst guests arrived and ate their fish and chips"

**PALLET
TRACK**

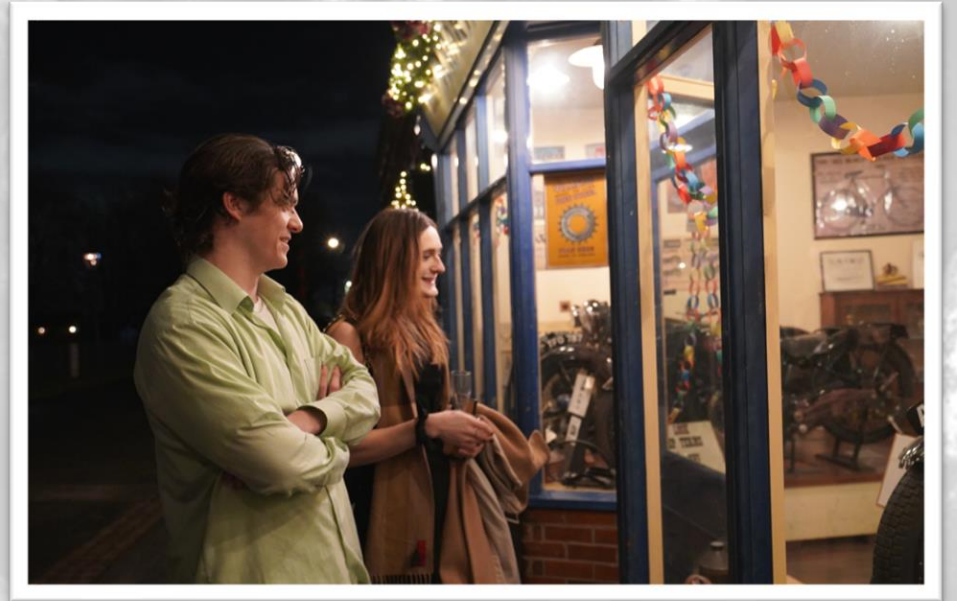

EXCLUSIVE EVENING STREET HIRE: 1940s-60s Street

Hireable on evenings from 18.00 – 22.30

We recommend a minimum of 80 delegates for this experience.

Step into living memory in our new 1940-60s town.

This hire includes:

- Hobbs & Sons Fish and Chip Shop
 - The Workers' Institute
 - The Elephant and Castle
- The West Brom Building Society
 - Stantons Radio Shop
 - Laurie Thomas
- Halesowen & Hasbury Co-operative
 - Springhill Post Office
- 1x roaming character, 4x shop characters

Folkes Park can provide the perfect setting for outdoor entertainment in addition if needed.

Combine with our other historic experiences for a larger event.



ENHANCE YOUR EVENT

Enjoy a truly authentic Black Country event with our exclusive on-site experiences.

GUIDED TOURS

Unearth 300 years of history as you explore the shops, houses and industrial workshops of our Canalside village with one of our knowledgeable Historic Characters.

1912 SCHOOL LESSON

Experience a private 30-minute lesson in St. James' School – be careful not to get the cane!

UNDERGROUND DRIFT MINE EXPERIENCE

Explore a maze of underground roadways and working areas, experiencing the sights and sounds of a miner's day.

DEMONSTRATIONS

Engage in our demonstrations and watch the craft that goes into the creation of chains and bricks, or discover a 1950s aluminium casting process at our Industrial Quarter.

MOTHER CRAFT CLASSES

Join us in our Infant Welfare Centre and learn from our Midwife about how to care for a newborn as a 1960s new parent. Learn how to swaddle, tie nappies and hear about early rollouts of the vaccine programs.

VINTAGE TRANSPORT

Set the tone for your event and get your guests talking with a journey on one of our vintage vehicles, from our iconic Midland Red double decker to the Guy Motors 252 single decker and other options.

MUSICAL ENTERTAINMENT

Whether it's a traditional pub sing-along, choir, band or crooner, we can source the right act and staging for you.

EVENING ENTERTAINMENT

From spectacular fire-breathing displays, magicians to stilt walkers, however wild your request our team can work with you to create a truly memorable event.

FAIRGROUND

Incorporate our vintage Fairground into your event and your guests can enjoy rides including the Super Sonic Jets and the Chair-o-plane.



CATERING

We have a separate catering brochure displaying a range of options to suit you and your guests. Please contact the team at venue@bclm.com for more information.



HOTEL AND TRAVEL INFORMATION

Learning and Conference Centre, Tipton Road, Dudley, DY1 4SQ

How to find us

Car parking is included in all hire charges and will be free for you and your guests.

For all hire events, please make your way to our Conference Centre, within Car Park 2, located just off Tipton Road, postcode DY1 4SQ. This is a separate entrance to our normal visitor entrance.

Birmingham City Centre- 40 minutes by car, 46 minutes by train (New St)

London City Centre- 2 hr 41 minutes by car, 2 hr 36 minutes by train (Euston)

Manchester City Centre- 1 hr 51 minutes by car, 1 hr 58 minutes by train (Piccadilly)

Hotels

There are several hotels in walkable distance of the Museum, including:

[The Village Hotel, Dudley](#)

[Travelodge Dudley Town Centre](#)

[Premier Inn Dudley Town Centre Hotel](#)

Please enquire upon completion of your booking to secure your individual discount code or block booking discounted rate for The Village Hotel.



BLACK COUNTRY LIVING MUSEUM

THANK YOU

venue@bclm.com | 0121 557 9643

[bclm.com](https://www.bclm.com)

